

80Mbit/s Digital Optical Links for Control, Timing and Trigger of the CMS Tracker

Part I. System Overview
Part II. Prototype Testing

Anne Marie Sandvik
CERN



Tracker Optical Links

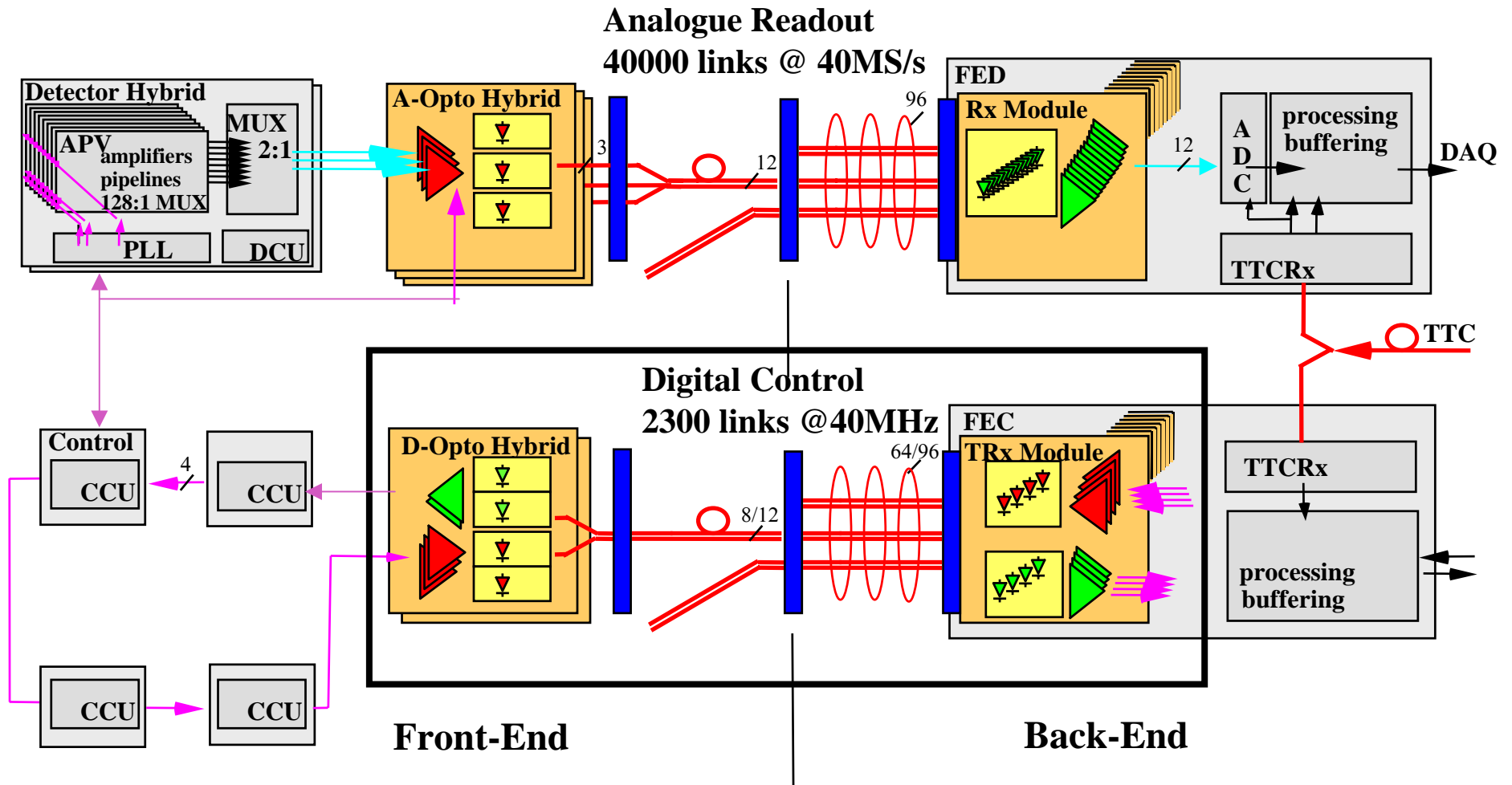



Tracker Requirements

Item	Min	Typ	Max	Notes
Wavelength (nm)		1310 nm		To share analogue readout link components
Speed (Mbit/s)	2		80	
Bit-error-rate		10^{-12}	10^{-9}	
Jitter (ns)			0.5	rms
Skew (ns)			2	Fibres to or from same optohybrid

•Tracker environment

- $T \sim -10^{\circ}\text{C}$
- $B = 4\text{T}$
- 150kGy & $3 \times 10^{14} \pi/\text{cm}^2$ radiation dose
- 10 years min. lifetime



System implementation

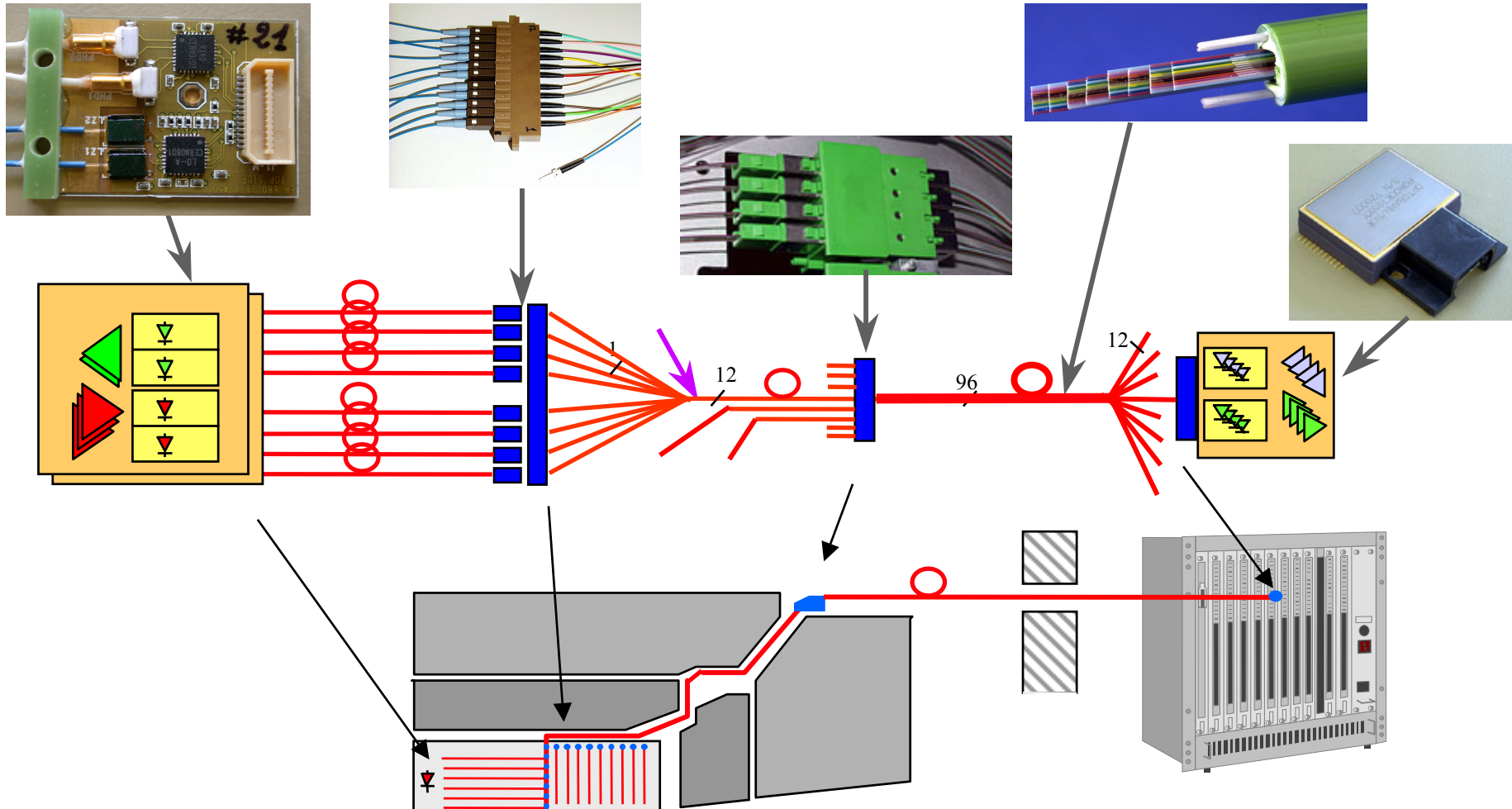

Final p-i-n diodes and back-end Transceiver still to be procured



Part Two

Prototype testing



Prototype Testing

- DOH (3/5 Parts)

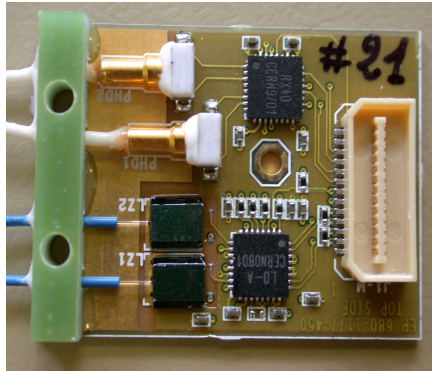

ASIC made at CERN
Dimensions:
Footprint: 35x25mm
Height : 5mm

- TRx (5/10 Parts)



Commercial 4 way
2.5 Gbit/s Transceiver
from NGK Optobahn

Measurements	Digital optohybrid	NGK Transceiver
Optical Power	X	X
Sensitivity	X	X
Saturation	X	X
Reset	X	
Minimum Data Rate		X



Measurement setup DOH

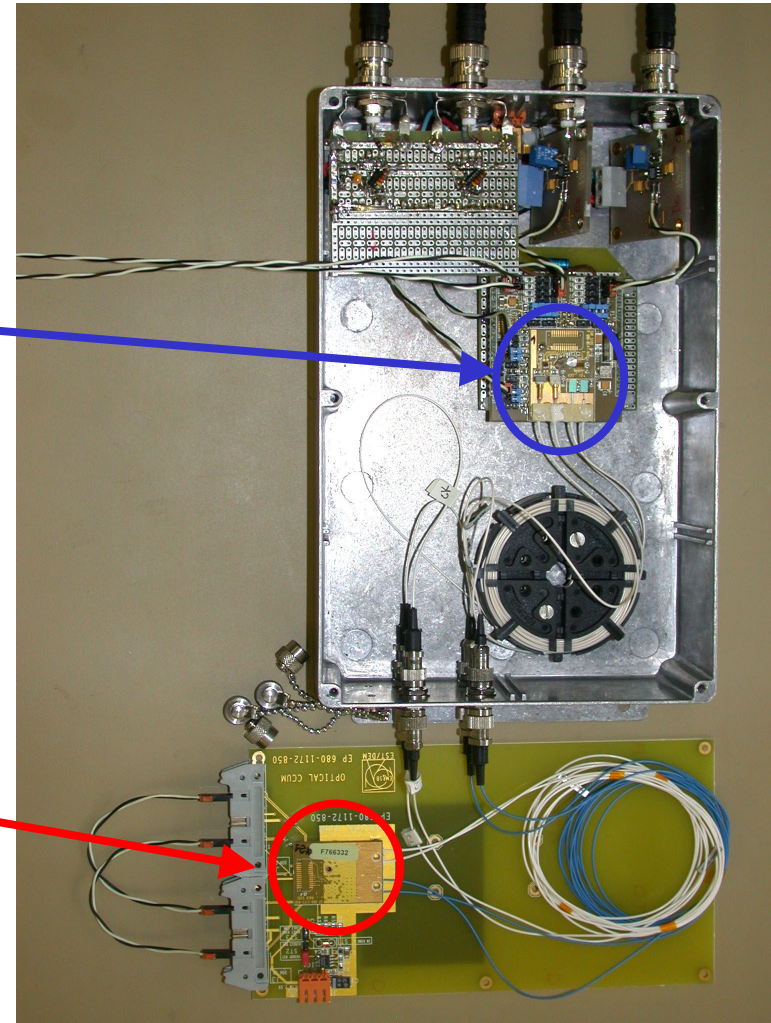
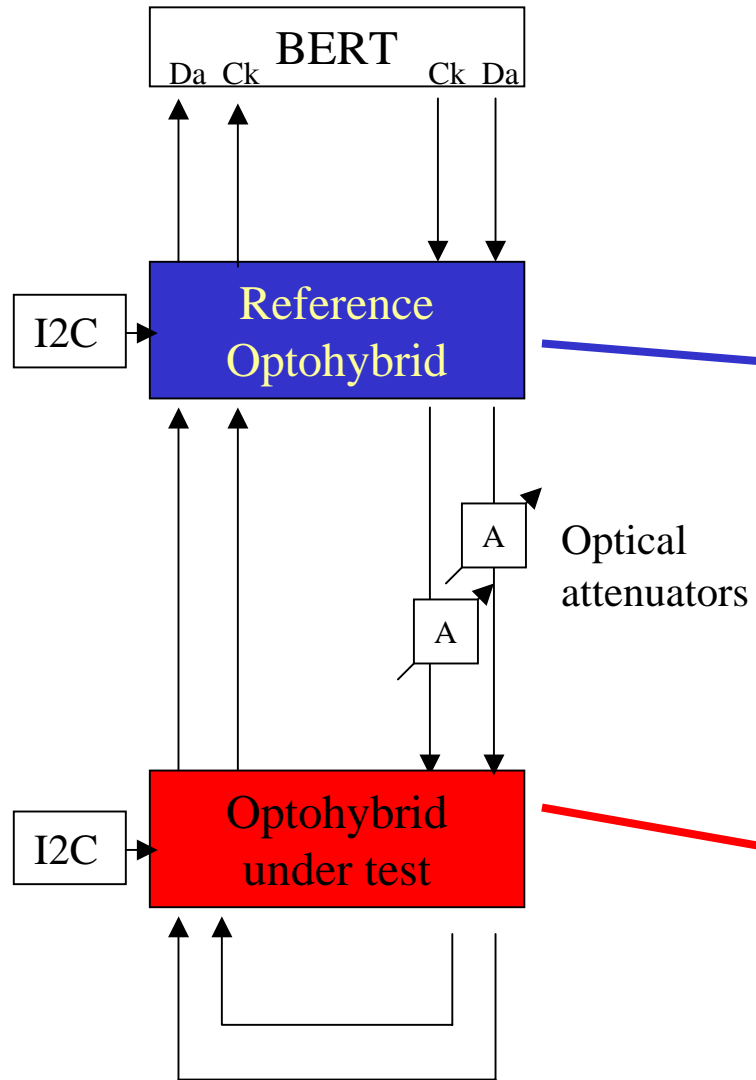



TRx test setup

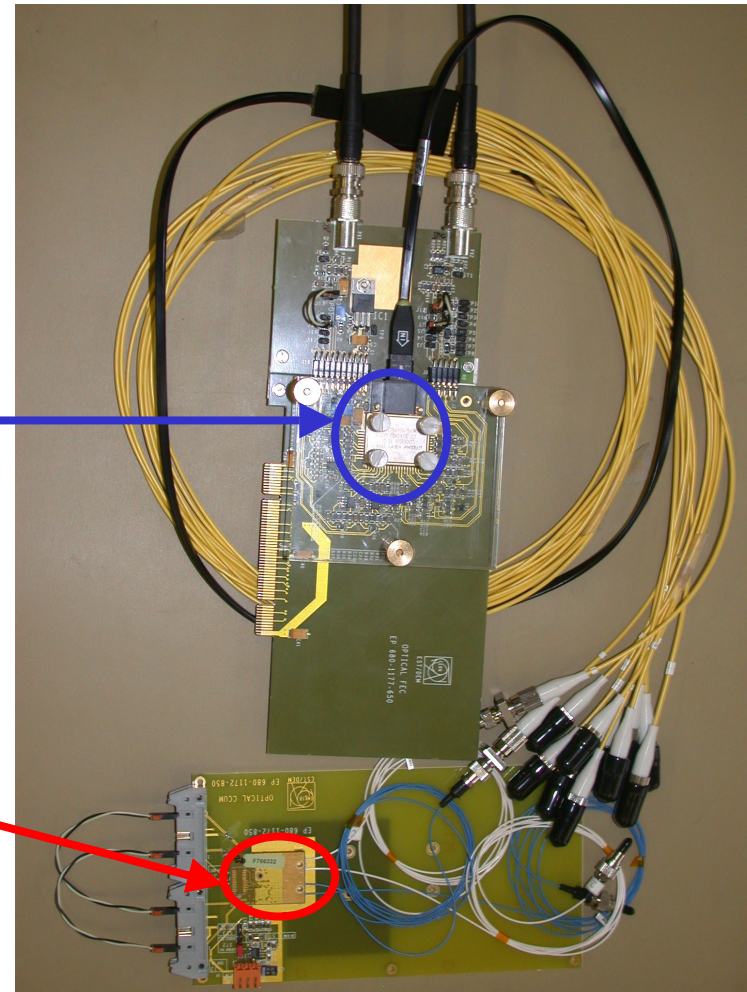
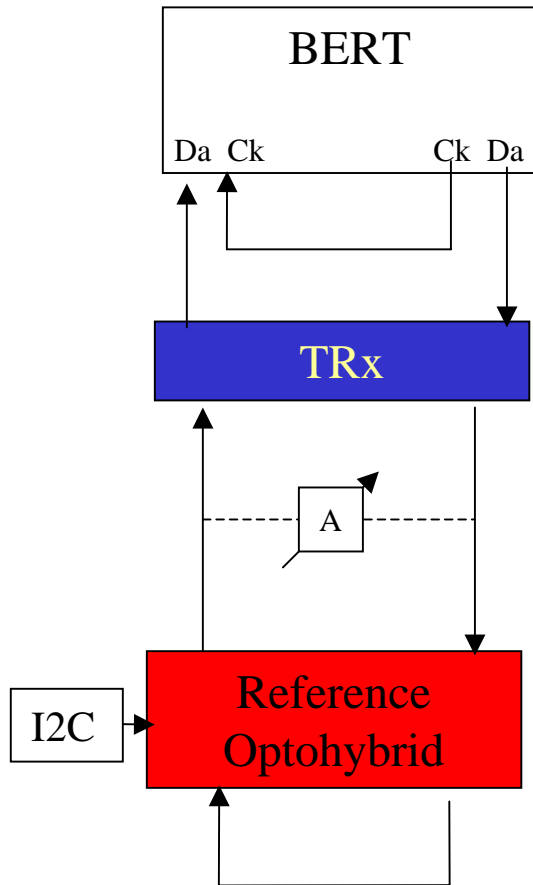



Tx Characteristics

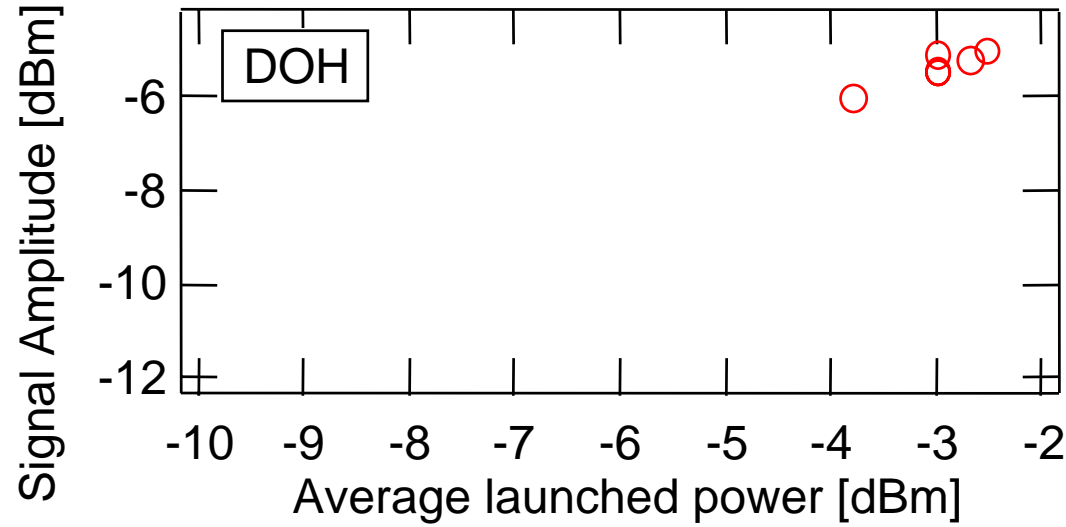

Typical eye-pattern from TRx

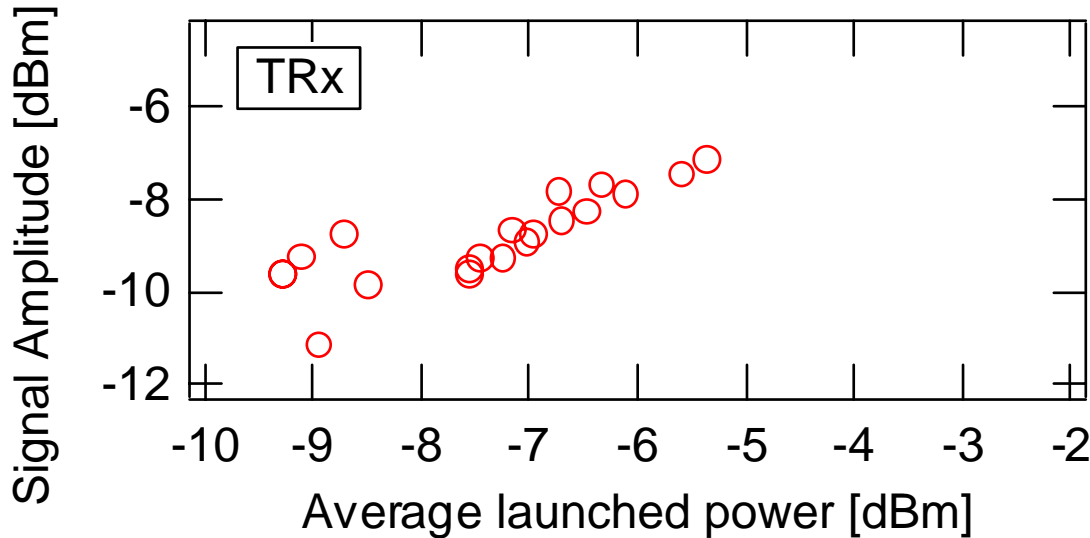
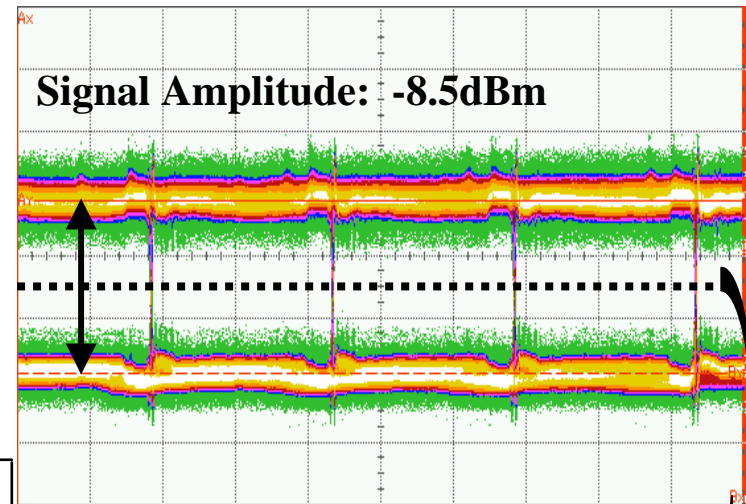

Average launched power: -6.7dBm



Rx Sensitivity & Saturation

Example of bit-error-rate versus average launched power

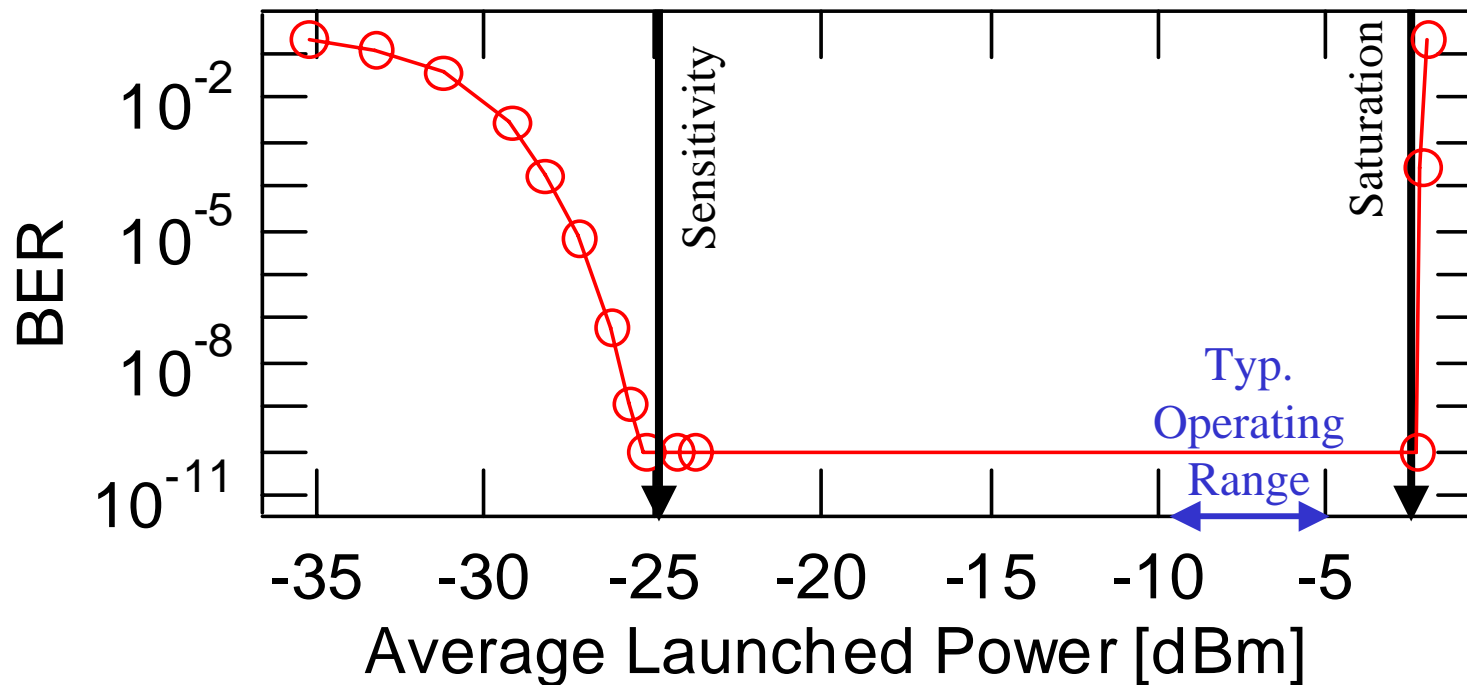



Rx characteristics

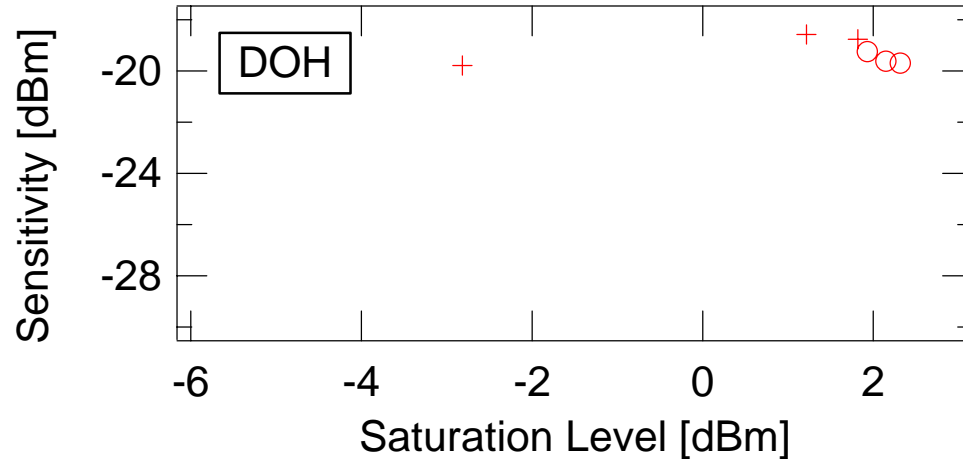

•DOH

- RX40 Specs
- Sensitivity ~ -20 dBm
- Saturation ~ -3dBm

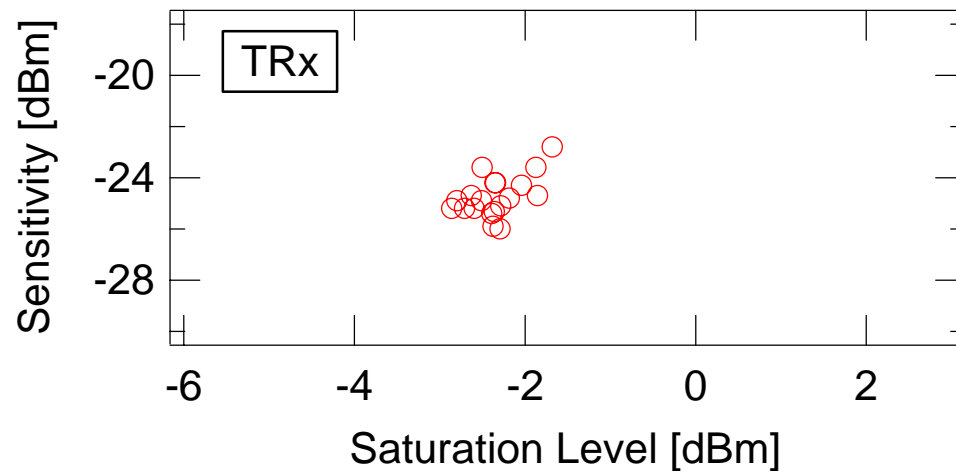

•TRx spec :

- Sensitivity ~ -18 dBm
- Saturation ~ -5 dBm



Full link

- Full link made with DOH, TRX, 100m cable + 3 'patch-panels'

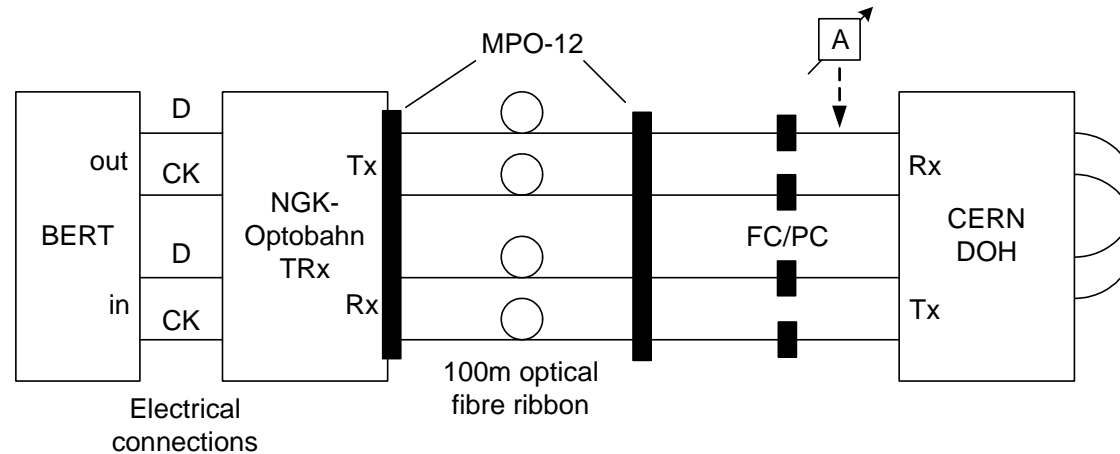

- Optical power margins measured in each channel
 - optical attenuation increased to point where errors occur or link fails
 - From DOH to TRx
 - From TRx to DOH
 - Clock: ~17.5dB
 - Data: ~17.5dB
 - Clock: ~9.5dB
 - Data: ~10dB
- Two Links tested with attenuation for 15 hours without any errors → $BER < 3 * 10^{-13}$



Summary

- 80Mbit/s digital links developed at CERN for CMS Tracker control
 - will also be used by ECAL, Preshower and Pixels
- Philosophy has been to (re)use analogue link components
- Extensive testing of the prototype DOH and NGK-TRx
 - Devices work well and compatible with intended link system
 - Testing procedures in place for production
- Full prototype link with DOH, TRX and realistic cabling tested
 - operates with a large safety margin
 - BER < 10^{-12}
- The remaining specs and interfaces to be frozen end of 2002, procurement of devices to start in 2003



- More information on the Digital Optical Links:

<http://cern.ch/cms-opto>